



The best energy is ready to go.

Welcome to the new Titanium range.

FIAMM
+ —





New Titanium range: experience and innovation.

The new **TITANIUM** range comes from FIAMM expertise and technology, resulting from the OEM first outfit, manufacturing process and technology business nowadays available in the spare parts market, a top level product with a strong Italian personality.





The best among the best.

Now FIAMM is the **world leader** for top quality starter batteries for the first outfit of some of the world's most prestigious car manufacturers, that is: **Opel-Vauxhall, Mercedes Benz, Peugeot-Citroën, Renault, Ferrari, Maserati, FCA Group, Volvo, Jaguar, Toyota** and **Nissan**.



Definitely FIAMM.

TITANIUM PRO and **black TITANIUM** are FIAMM quality products, meet the European EN reference standards, contribute to respect for the environment with the programme for **exhaust battery recovery called "Raccolta Amica"*** and are recommended by the specialists of **FIAMM Network**. FIAMM can count on a many sales points including workshops, car electricians and spare parts vendors specialised in energy in Italy. FIAMM has privileged the relationship with these professionals since the start. This relationship, in addition to the many signs found nationwide, has allowed us to acquire notoriety and become known by motorists too. There are **more than 1200 workshops** which, all over Italy, **joined the programme of FIAMM Network** obtaining benefits as for visibility, recognisability, dedicated discounts and promotions.

* AVAILABLE IN ITALY ONLY.

TITANIUM

PRO

TITANIUM PRO: maximum power for the most demanding requirements by modern cars, in the most common European sizes (DIN), with the certainty of a **100% Italian** product.

SPC (Safety Power Checked) cover used by the European car manufacturers, maintenance free according to EN 50342 standard and qualified as **MATCHING QUALITY SPARE PART** according to the European regulations EU 461/2010 are the main product benefits.

Useful **Check Control** on the whole range, for a quick check of the best load conditions.



SPC (Safety Power Checked) cover



It is available on all batteries, "L" and "LB" series, in the **TITANIUM** range: the SPC (Safety Power Checked) cover has a ducting system with a single gas exhaust port and a flame arrester pad, inside the cover, to zero the risks caused by occasional sparks or open flames outside of the battery. The SPC cover is currently used as first outfit on all new vehicles of the major car manufacturers.

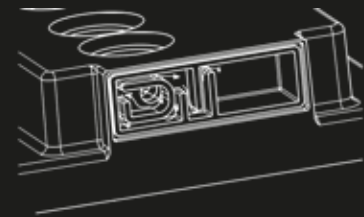
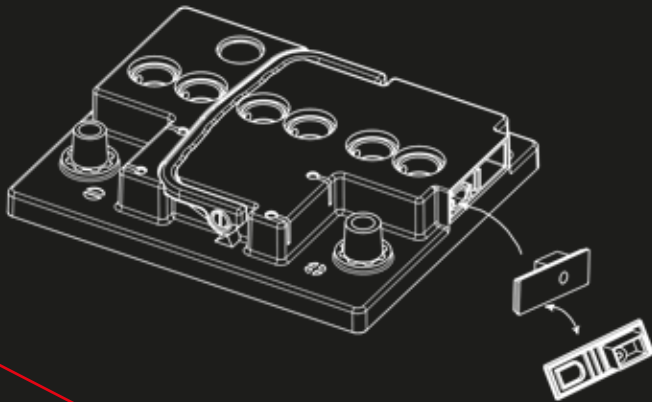

MATCHING QUALITY SPARE PARTS



FIAMM original batteries are produced at the same manufacturing plants where the first outfit components are manufactured; they are all certified according to the Automotive ISO/TS 16949 standard, using the same technology, labour, tooling and controls approved by the car manufactures concerned.

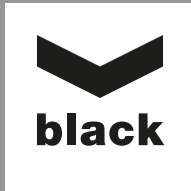

TITANIUM

black TITANIUM: the whole FIAMM experience for a safe start.

SPC (Safety Power Check) cover used by European Car Manufacturers,

Maintenance-free condition according to EN 50342 standard,

for a FIAMM quality product at the right price.









Maintenance-free according to EN 50342 standard



TITANIUM range batteries do not require any top up all life long. Water consumption is so low that the factory reserve of electrolyte is enough for all the years of battery utilisation.

According to the current EN 50342-1:2006-04 standard on L and LB TITANIUM series batteries, the water consumption level is lower than 1 g/Ah.

FIAMM: the best services tailored for you.

APP		iParts FIAMM	The FIAMM application allows you to find out the right battery for any car model, very quickly. All the types of batteries come with a picture and technical specifications for an easier identification.
		iOfficina FIAMM*	FIAMM Network Workshops can be reached and consulted thanks to an application that suggest the FIAMM closest Workshops and Car electricians, calculating the route to reach them.
WEB		fiamm.com	The company site of FIAMM Group
		fiammnetwork.com*	The portal serving workshops and motorists.
		Raccoltaamica.com*	The web site dedicated to the "Raccolta Amica" project, for a correct disposal of exhaust batteries.
		Motorenergy.it	The site dedicated to products for motorcycles, scooters, snowmobiles, ATV and Jet Sky.

*FOR ITALY ONLY



facebook.com/fiamm.batteries



twitter.com/fiammbatteries



youtube.com/user/FIAMMvideo

TITANIUM



ID code	FIAMM code	Capacity (Ah)	CCA (A EN)	Dimensions LxWxH (mm)	Terminal polarity	Terminal*	Base fastener
L0 44P	7905140	44	390	175x175x190	(0) RH	1	B13
L1 44P	7905141	44	390	207x175x190	(0) RH	1	B13
L1B 44P	7905142	44	420	207x175x175	(0) RH	1	B13
L1 50P	7905143	50	460	207x175x190	(0) RH	1	B13
L1B 50P	7905144	50	520	207x175x175	(0) RH	1	B13
L1 54P	7905145	54	520	207x175x190	(0) RH	1	B13
L2B 54P	7905146	54	540	242x175x175	(0) RH	1	B13
L2 60P	7905147	60	540	242x175x190	(0) RH	1	B13
L2X 60P	7905148	60	540	242x175x190	(1) LH	1	B13
L2B 60P	7905149	60	600	242x175x175	(0) RH	1	B13
L2 64P	7905150	64	610	242x175x190	(0) RH	1	B13
L2X 64P	7905151	64	610	242x175x190	(1) LH	1	B13
L3 70P	7905152	70	640	278x175x190	(0) RH	1	B13
L3B 71P	7905153	71	680	278x175x175	(0) RH	1	B13
L3 74P	7905154	74	680	278x175x190	(0) RH	1	B13
L3X 74P	7905155	74	680	278x175x190	(1) LH	1	B13
L3B 75P	7905156	75	730	278x175x175	(0) RH	1	B13
L3 80P	7905157	80	730	278x175x190	(0) RH	1	B13
L4B 85P	7905158	85	760	315x175x175	(0) RH	1	B13
L5 90P	7905159	90	800	353x175x190	(0) RH	1	B13
L5 100P	7905160	100	870	353x175x190	(0) RH	1	B13

* 1 = DIN TERMINAL

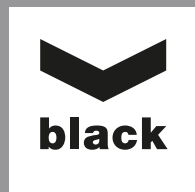

TITANIUM

ID code	FIAMM code	Capacity (Ah)	CCA (A EN)	Dimensions LxWxH (mm)	Terminal polarity	Terminal*	Base fastener
B19J 38	7905161	38	300	187x127x220	(0) RH	3	B00
B19JX 38	7905162	38	300	187x127x220	(1) LH	3	B00
B19JAK 38	7905163	38	300	187x127x220	(0) RH	3	B01
L0 40	7905164	40	330	175x175x190	(0) RH	1	B13
L1B 36	7905165	36	330	207x175x175	(0) RH	1	B13
L1 44	7905166	44	360	207x175x190	(0) RH	1	B13
L1X 44	7905167	44	360	207x175x190	(1) LH	1	B13
E2 45	7905168	45	330	218x133x223	(0) RH	1	B01
E2X 45	7905169	45	330	218x133x223	(1) LH	1	B01
B24 45	7905170	45	360	237x128x225	(0) RH	1	B00
B24X 45	7905171	45	360	237x128x225	(1) LH	1	B00
B24J 45	7905172	45	360	237x128x225	(0) RH	3	B00
B24JX 45	7905173	45	360	237x128x225	(1) LH	3	B00
D20 50	7905174	50	420	200x170x223	(0) RH	1	B01 int.
D20X 50	7905175	50	420	200x170x223	(1) LH	1	B01 int.
L2B 50	7905176	50	480	242x175x175	(0) RH	1	B13
L2 55	7905177	55	480	242x175x190	(0) RH	1	B13
L2 60	7905178	60	510	242x175x190	(0) RH	1	B13
L2X 60	7905179	60	510	242x175x190	(1) LH	1	B13
D23 60	7905180	60	540	230x170x223	(0) RH	1	B01 int.
D23X 60	7905181	60	540	230x170x223	(1) LH	1	B01 int.
L3B 66	7905182	66	600	278x175x175	(0) RH	1	B13
GR24 70	7905183	70	540	270x175x225	(0) RH	1	B07/B12
GR24X 70	7905184	70	540	270x175x225	(1) LH	1	B07/B12
L3 70	7905185	70	600	278x175x190	(0) RH	1	B13
L3X 70	7905186	70	600	278x175x190	(1) LH	1	B13
L3 74	7905187	74	640	278x175x190	(0) RH	1	B13
D26 75	7905188	75	640	257x172x220	(0) RH	1	B01
D26X 75	7905189	75	640	257x172x220	(1) LH	1	B01
L4 95	7905190	95	850	315x175x190	(0) RH	1	B13
L4X 95	7905191	95	850	315x175x190	(1) LH	1	B13
L5B 85	7905192	85	760	353x175x175	(0) RH	1	B13
L5 88	7905193	88	760	353x175x190	(0) RH	1	B13
D31 95	7905194	95	760	302x172x220	(0) RH	1	B01
D31X 95	7905195	95	760	302x172x220	(1) LH	1	B01
L6 110	7905196	110	950	394x175x190	(0) RH	1	B13

* 1 = DIN TERMINAL 3 = JIS TERMINAL



Fiamm Energy, new Titanium.

FIAMM
+ — — -

Headquarters

FIAMM Energy Technology S.p.A.

Viale Europa, 75

36075 Montecchio Maggiore (VI) - Italy

Tel. +39 0444 709311

Fax +39 0444 709878

A Hitachi Group Company

info.starter@fiamm.com

www.fiamm.com

www.fiammnetwork.com

 [fiamm.batteries](https://www.facebook.com/fiamm.batteries)

 [fiambatteries](https://twitter.com/fiambatteries)

 [youtube.com/user/FIAMMvideo](https://www.youtube.com/user/FIAMMvideo)



Find out all about
the new FIAMM
products using
the QR code!